



SERVICES

SIMONA[®] SmartTank

Efficient calculation of rectangular and cylindrical tanks

- s earthquake load
- s a collecting drip pan
- ry roofing
- ouble shell

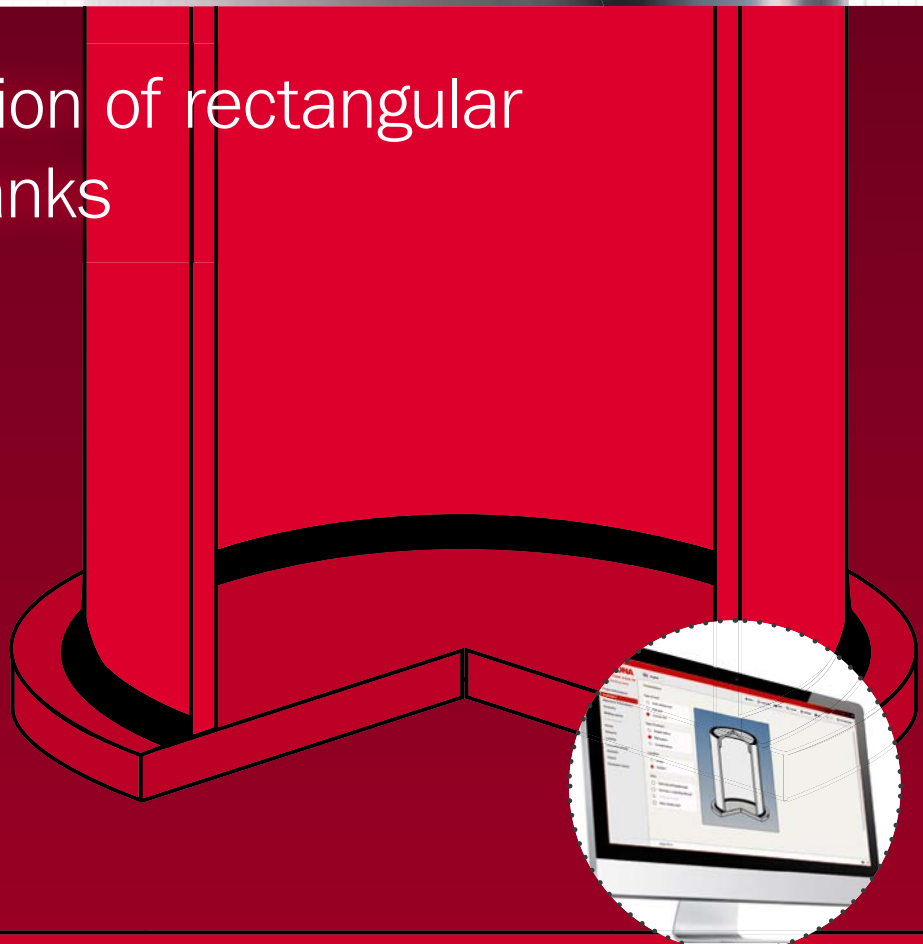

SIMONA® SmartTank – Tank analysis software that sets new standards

Our SIMONA® SmartTank structural analysis software offers you an exciting array of possibilities for calculating thermoplastic rectangular and cylindrical tanks. We are continuously enhancing our software so that you can look forward to innovative new program components and features that will enable you to maximise both cost-effectiveness and safety in the design of your tanks.

In tank and apparatus construction, two aspects are of essential importance: the right material that is tailored to your requirements and the right partner with the expertise needed to provide you with pertinent advice – from the selection of materials to pre-engineering in the field. SIMONA offers you the best of both worlds – premium product quality and excellent service.

In close collaboration with our development partner, LU Engineering Software GmbH, we have consolidated decades of experience in the area of tank analysis so that you can benefit from intelligent software. The software is designed to meet the needs of our customers and is intuitive to use. From program structure to the design of the user interface, the focus of SIMONA® SmartTank is always on user benefit.

The program offers you:

- Maximum cost-effectiveness in the design of tanks
- The option to export parameters to external programs (e.g. CAD software)
- Significant potential for cost savings thanks to realistic FEM formulation of circumferentially reinforced tanks and all the structural steel members, thus revolutionising the analysis of these components
- Network-capable application and administration of the software
- Centralised administration of all projects in a project manager
- Simple, convenient user guidance
- Plausibility check and validation of all inputs
- High-quality, verifiable and graphically sophisticated outputs as well as complete printouts
- Optimised service and support via hotline with ultra-fast response times



Software highlights at a glance

- + Geographical zone tool for the simplified input of wind, snow and earthquake loads thanks to postcode- or map-based geolocation
- + Parameter exports to external programs (e.g. CAD or FEM software)
- + Load calculations in accordance with SIA 261 and ASCE 7-10
- + Integration of the material PE-EL (electrically conductive polyethylene)
- + Tank analysis for shell design
- + Interactive sizing of wall thicknesses, shot limits and nozzles with error avoidance
- + Creep curves that can be displayed to the design engineer live as a special feature, depending on the operating conditions selected
- + Integrated miner tool for alternating temperature calculation
- + Wizard for calculating tank columns
- + Call up either the current DIBt media list or our SIMCHEM database
- + Calculation of rectangular tanks in accordance with the latest DVS draft (integrated FEM basis)
- + FEM calculation for flat roofs of rectangular and cylindrical tanks
- + SIMONA® twin-wall sheets module for calculating flat roofs of cylindrical and rectangular tanks
- + User-defined profile arrangement for circumferentially reinforced tanks
- + Profile maker for creating and administering custom reinforcement profiles
- + Materials manager to customise material definition for reinforcements

You can also obtain detailed information on the software online at www.simona.de/smarttank, in our [training video](#) or directly from the SIMONA Technical Service Centre.

i Technical Service Center
SIMONA AG
Phone +49 (0) 67 52 14-587
tsc@simona-group.com

i Dr.-Ing. Ingo Lukas
LU Engineering Software GmbH
Phone +49 (0) 63 02 982 844
i.lukas@lu-software.com

SIMONA® SmartTank turns cost and time savings into something you can design

Our expertise continues to develop further – and SIMONA® SmartTank continues to grow. The program is being continuously optimised so it always reflects the state of the art. The “parameter export” function that comes with the fourth generation of the SIMONA® SmartTank software allows you to export virtually all the key data on a tank supplied by the structural calculation into user-defined lists with a single click.

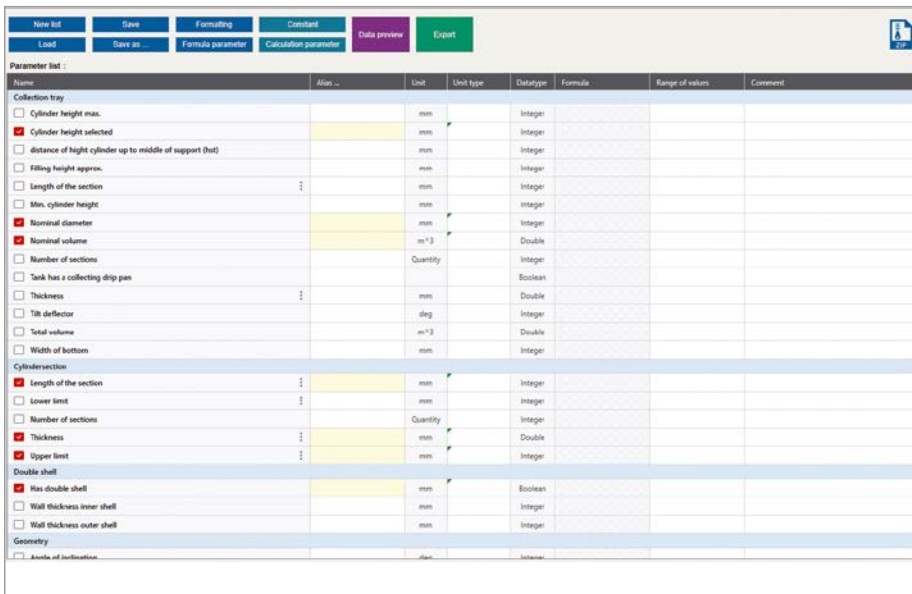

Parameter selection window

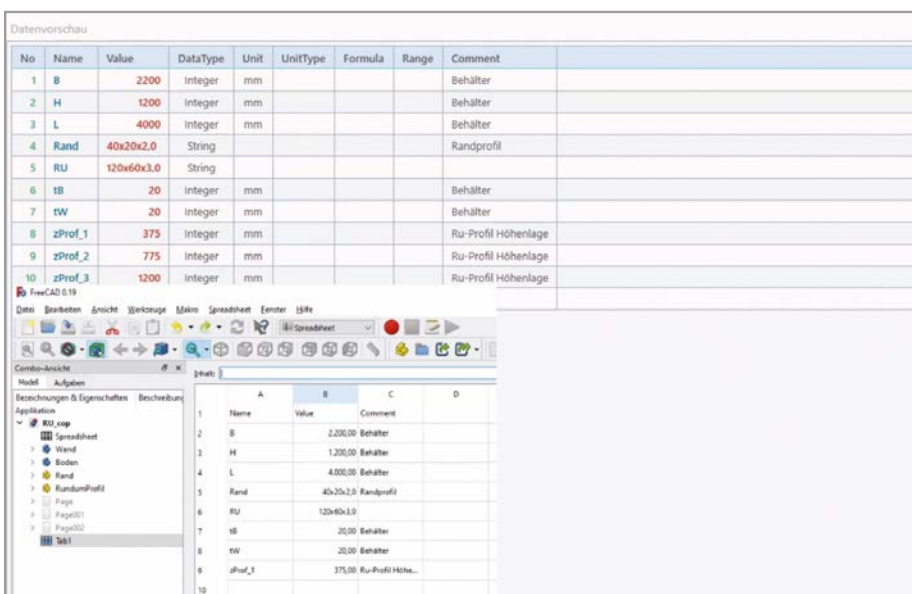

Defining values for parameters

The data exported can be read in parametrically by external programs (such as CAD and FEM software and Excel spreadsheets) and processed further, making technical and commercial work on the tank easier and quicker.

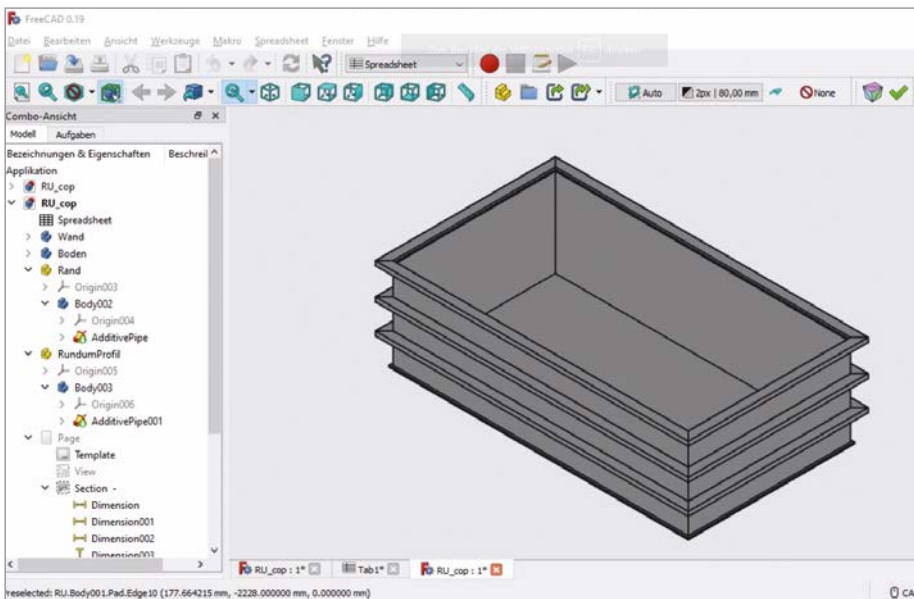

Example: exporting to the "FreeCAD" CAD program

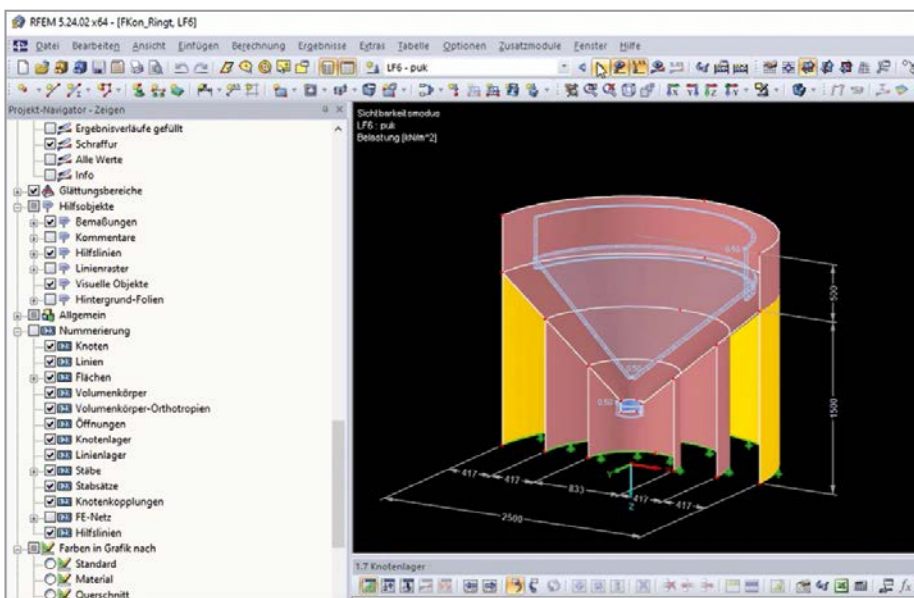

Example: exporting calculation data for a conical floor to an FEM environment

Standard features of SIMONA® SmartTank

Our tank analysis program SIMONA® SmartTank was unveiled at the plastics trade fair in Düsseldorf in 2016. With innovative analysis modules, an extremely user-friendly environment and top-quality structural analysis documentation, SIMONA® SmartTank remains unique within the market. Here are some of the highlights that still constitute an integral part of the program:

1. Miner tool

The miner tool integrated into SIMONA® SmartTank makes it possible to enter different temperatures and their length of exposure when specifying a mean operating temperature over the service life of the tank.

2. Tank column calculation

Within the program, a copy of an existing tank can be generated and customised with a few mouse clicks in order to process several series of tanks within a very short space of time.

3. Call up either the current DIBt media list or the SIMCHEM database

In addition to the SIMCHEM database, the alternative option of a DIBt list of substances is also included.

4. FEM calculation for flat roofs of rectangular and cylindrical tanks

Especially if the flat roof is to be rated as walk-on, the analytical methods applied within DVS 2205 call for relatively conservative analytical assumptions that generate considerable wall thicknesses and also require the roof to be reinforced. The FEM calculation methods integrated in SIMONA® SmartTank make this superfluous; the wall thickness of the tank roof can thus be reduced by a significant margin.

5. SIMONA® twin-wall sheets module for calculating flat roofs of cylindrical and rectangular tanks

SIMONA® twin-wall sheets are characterised by significant flexural strength. Thanks to the calculation concept developed by LU Engineering Software GmbH, this product can be used for the purpose of conventional tank construction. In connection with the FEM sizing module integrated into SIMONA® SmartTank if a maintenance agreement has been concluded,

the number of stiffeners or the cross sections thereof can be reduced or an arrangement of stiffeners can even be omitted completely. This brings about a considerable reduction in the weight of the roof.

6. Calculation of rectangular tanks according to the latest DVS standards

Calculation of rectangular tanks is performed in accordance with DVS 2205-05. The draft of the newly written 2205-05 information sheet appeared at the beginning of 2020. The new sheet guides the user through the analysis process in much greater detail and corrects any calculation models that were too conservative. One key item that was changed is the option of still being allowed access to FEM analyses in compliance with this information sheet.

This opens up possibilities including:

- Consideration of the coupling of tanks and stiffening profiles: if the analytical relationships are used for dimensioning according to DVS 2205-05, the reinforcement profiles must be designed by applying the following conditions.

Reliable profile deformation of the reinforcement profiles for circumferentially reinforced tanks and cross-ribbed tanks:

- $w_{p,1} \leq 0.01 \cdot b_1$ Span height of the first span
- $w_{p,i} \leq 0.01 \cdot b_i$ Span height below in the i-th span

During a sizing process with the aid of FEM, this requirement does not apply because the relationship between rigidities and their impact on design variables are identified directly and the quantities of steel are thus reduced substantially.

- Detection of the real stress distributions within a tank: knowledge of the real stress characteristics within the tank enables optimal exploitation of the existing material reserves.
- Independent thicknesses of floor and wall: the analytical calculation specifications of DVS 2205-05 assume full clamping between floor and wall and thus at least

identical wall thicknesses of both components. Within FEM, different wall thicknesses can be used for sizing the tank and both components can be sized with adequate stability.

- Tank roof dimensioning using FEM.

The rectangular tank module in SIMONA® SmartTank calculates all the tank types defined within DVS 2205-05 using FEM and thus optimises the sizing of rectangular tanks. The program handles all tasks for the user and discretises, optimises and evaluates the data in the background. Therefore, knowledge usually needed for the application of FEM is not required.

7. User-defined profile arrangement for circumferentially reinforced tanks

Apart from the optimised profile layer made available by SIMONA® SmartTank in order to ensure a specified wall thickness for circumferentially reinforced tanks, it is also possible to specify a profile layer by graphical interaction and have SIMONA® SmartTank calculate the relevant wall thickness. In addition to the option of moving profiles, profiles can also be added or deleted.

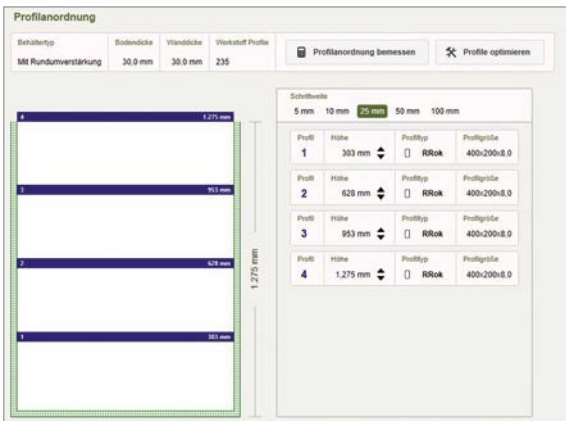

8. Profile maker

SIMONA SmartTank's rectangular module comes with an integrated profile maker. Once this has been activated, a dialogue window opens and displays all profiles that can be defined by the user. After selecting a profile type, all the necessary cross-section data is requested, the necessary cross-section values are calculated by the SIMONA® SmartTank program and they are then made available for sizing. Exotic profile series or self-created welding profiles can thus also be handled even in those cases in which users have little background knowledge with regard to structural engineering.

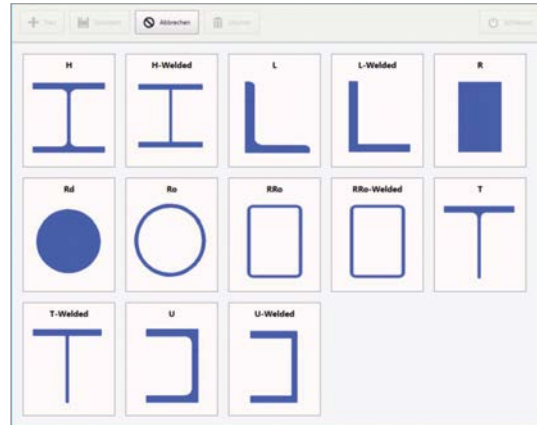

9. Material manager

Thanks to the integrated material manager, the user can define any material and use it to calculate stiffening profiles. Application is amazingly simple. After activating the material manager, the user is shown all existing materials in the program and can add a new material by pressing the "+" button. Then, within the menu that opens up, a unique material name has to be issued and the material values requested have to be entered. After saving, the material is available for all future dimensioning.

10. Geographical zone tool

The geographical zone tool determines wind, snow and earthquake loads within a region selected by the user. From a simple drop-down menu, the user can systematically select almost every country in the European region and the required parameters are automatically read out of the database, which contains over 80,000 stored data records. As a result, it is no longer necessary to make manual entries. At the same time, the geographical zone tool visualises the location on a graphically interactive map to enable the user to check output.

The geographical zone tool thus offers you:

- Convenient detection of all basic load data
- Visual checking of input location
- Automatic consideration of the respective national annex and/or national standard
- Ultra-fast specification of all wind, snow and earthquake loads

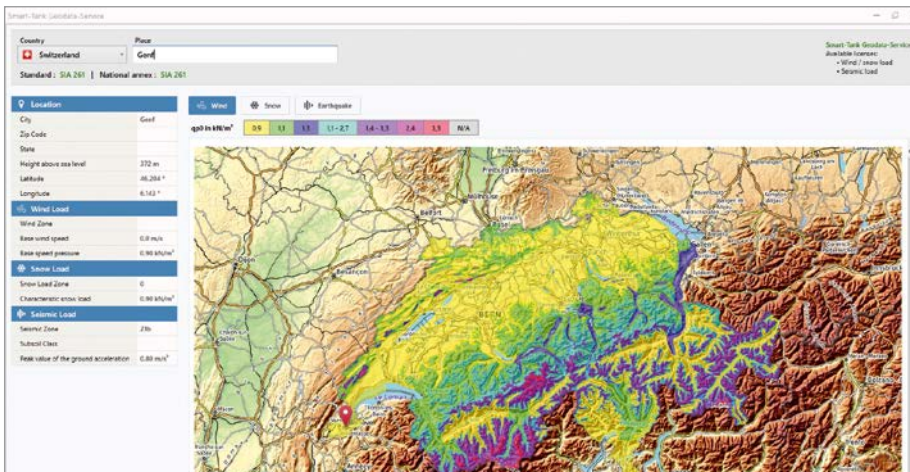
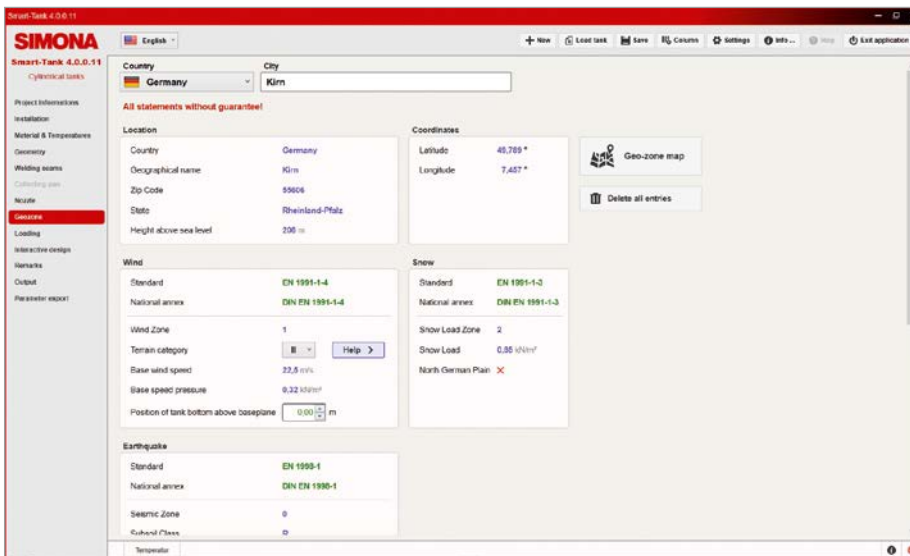

Map view for geolocation with regard to wind, snow and earthquake loads.

Geolocation can be performed either by using a drop-down list or in map mode. In the latter case, the respective zones are clearly visualised so attention is drawn to borderline areas (characteristic of the respective load zone). The geographical zone tool is linked to the Eurocode and Swiss standard SIA 261.

11. Load determination in accordance with SIA 261 and ASCE 7-10

SIMONA® SmartTank enables load determination in accordance with SIA 261 and ASCE 7-10 for the load cases of snow, wind and earthquake. This module can also be used manually, irrespective of whether the geographical zone tool is being applied.

12. Integration of the material PE-EL (electrically conductive polyethylene)

The material PE-EL – an electrically conductive polyethylene – has been integrated into SIMONA® SmartTank with its long-term data. Thus, it is also possible to calculate tanks made of this material.

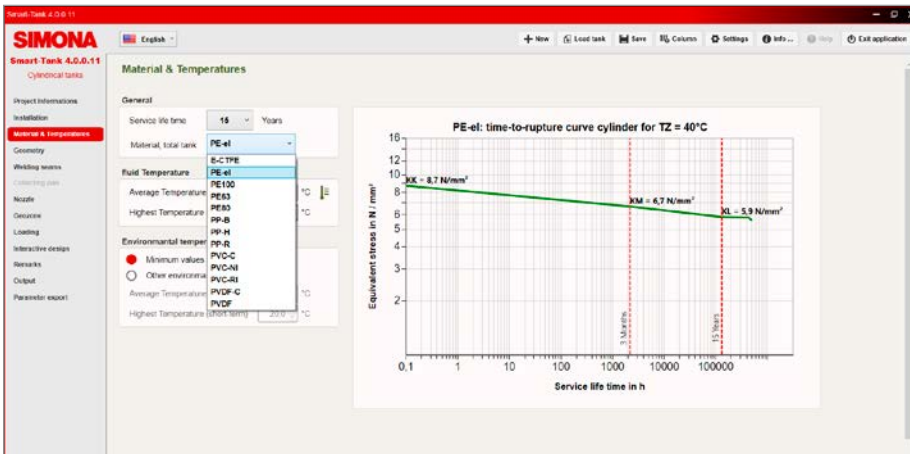

13. Uplift safety

DVS 2205 requires evidence to be produced of adequate uplift safety inside a drip pan in the event of damage. SIMONA® SmartTank generates the relevant evidence and documents it in a verifiable manner within the structural analysis. In this context, the program supports both procedures that are

possible according to DVS 2205-2:

1. Proof of a suitable retaining structure
2. Proof of enlargement of the inside diameter of the drip pan (takes place automatically in the program)

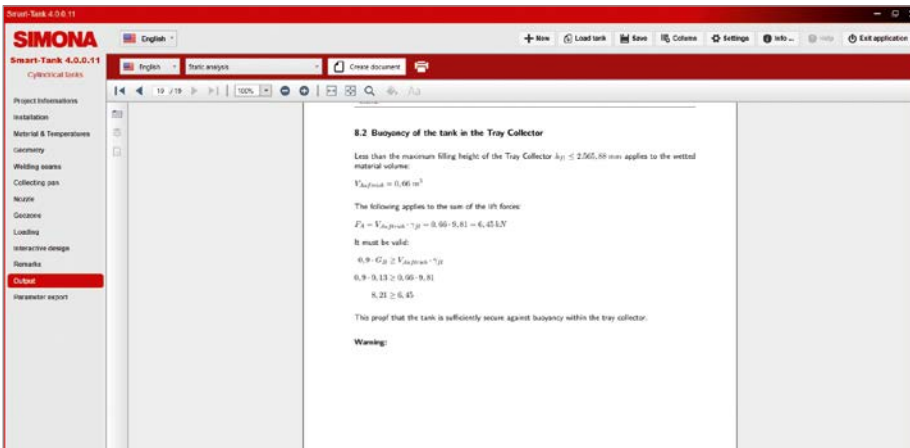

14. Tanks of shell design – tensile strength monitoring

If sheet-based tanks exceed the permissible strain limitations for the material used owing to their media load, DVS 2205-2 Supplement 6 permits a wider shell to be specified. For this

purpose, SIMONA® SmartTank generates all the necessary proofs and documents them in a verifiable form.

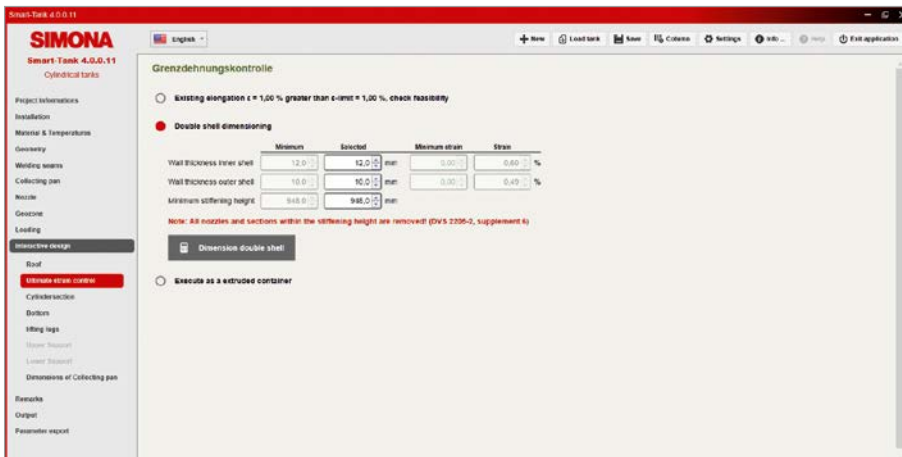
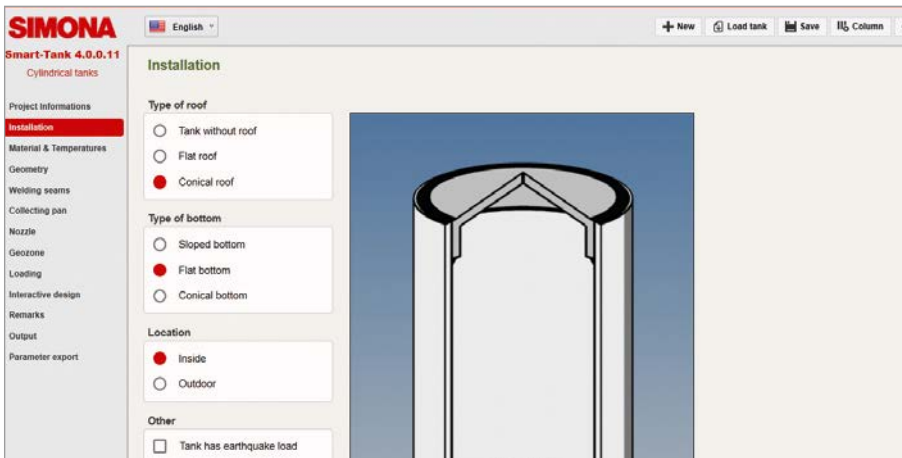

Prices and services

Full version of SmartTank including all packages	On request
Service agreement per full version	€1,550.00 p.a.
Expansion licences	On request

Talk to us for advice and a no-obligation quote:

i Technical Field Sales
 Jan Michel
 Phone +49 (0) 151 4286 8027
 jan.michel@simona-group.com

An exclusive service from SIMONA and LU Engineering Software GmbH

Together with our development and service partner LU Engineering Software GmbH run by Dr.-Ing. Ingo Lukas, we have put together an attractive service package for you. Thanks to your service agreement, you will always be at the cutting edge with your support and future updates. Consequently, it is no longer necessary to obtain new updates of the entire program or individual modules.

Benefits of a service agreement at a glance:

- Innovation
- Safety
- Value retention
- Profitability
- Cost control
- Reduction of software outages

Our software is subject to ongoing further development and improvement and is made available to download from our server. You will be notified automatically and can be sent the download link on request.

Survey updates:

- New functions, extensions and improvements of the software and the available versions
- Standard-dependent software updates (e.g. in the event of changes made to a national standard)
- Changes made to DVS rules

Here are the details of the services provided under a service agreement:

- Maintenance of the current version and the preceding version
- With every new main version and every new service pack, a detailed list of all the bugs fixed is offered in the protected

download area. That list is only available to customers with a service and support agreement.

- Automatic provision of updates (bug fixes, minor software modifications) to all programs in the software suite for which the service contract was concluded (up to three times a year; downloaded via Dlubal extranet).
- Telephone support and guaranteed call-back if you are unable to talk to any of our service technicians immediately
- Preferential treatment in hotline support
- Online support via videoconference if required
- Discounts on future upgrades (major chargeable further developments) of the main programs
- Discounts on the fees for advice and project management by our IFKI engineering team in the event of complex problems that our software modules cannot handle

Please note: unlike updates, upgrades are versions of the software that have been very heavily overhauled or even completely reprogrammed. It is not possible to skip upgrades. This means that you cannot upgrade directly from version 1.xx of a program to version 3.xx if a version 2.xx exists. All intermediate versions must be complied with and acquired. With a service agreement, you are entitled to reduced-rate upgrade terms.

We are happy to discuss this with you.

Welcome to SIMONA – Put your trust in expertise and service



With our focus on thermoplastic sheets, pipes and fittings, we are the leading premium provider to global growth industries. We supply our end customers with top-quality thermoplastic products all over the world. We offer unbeatable solutions for your industrial, infrastructure, mobility, aquaculture, advertising and construction applications.

Our customers benefit from our first-class advisory service. Our employees are specialists in their field and have years of experience in the manufacture and processing of plastic components. Whether it involves tank and apparatus construction, interior linings or pipeline construction, our experts will be pleased to assist you with product selection and also help to answer questions about the use of our products. It's advice you can rely on.

i Phone +49 (0) 67 52 14 -587
Fax +49 (0) 67 52 14 -302
TSC@simona-group.de

GLOBAL THERMOPLASTIC SOLUTIONS

Contacts and more:

simona.de/worldwide



SIMONA AG

Teichweg 16
55606 Kirn
Germany

Phone +49 (0) 6752 14-0
Fax +49 (0) 6752 14-211
mail@simona-group.com
www.simona.de

Follow us on:

